



# Water Designs

- 209 Sheer Descent<sup>®</sup>
- 216 Sheer Descent Ordering Instructions
- 217 Sheer Descent Technical Information
- 219 Sheer Descent Radius Cut Guidelines
- 220 Zodiac Water Designs<sup>®</sup>
- 225 Aqua Accents<sup>™</sup>
- 229 Laminar Jets/Deck Jets
- 231 Accessories
- 232 Parts





**Sheer Descent  
Waterfalls**

## Sheer Descent® Waterfalls

Sheer Descent waterfalls produce a clear arc of water, projecting away from the pool wall. The flow can be adjusted to create a range of effects from an almost silent, glass like sheet of water to a rushing mountain spring waterfall. Sheer Descent Waterfalls are available in a variety of lengths with a choice of white, light gray or clear lip colors.

- Creates a clear sheet of water that descends gracefully to the pool surface
- PVC construction
- X-Baffle™ construction

Part No.	Size	Description	List Price
<b>1" Standard Lip Waterfall - Back Feed</b>			
White Finish			
1101003	1'	Sheer Descent, White Lip	\$261.57
1118003	18"	Sheer Descent, White Lip	\$306.74
1102003	2'	Sheer Descent, White Lip	\$325.79
1103003	3'	Sheer Descent, White Lip	\$413.77
1104003	4'	Sheer Descent, White Lip	\$527.91
1105003	5'	Sheer Descent, White Lip	\$654.02
1106003	6'	Sheer Descent, White Lip	\$782.34
1107003	7'	Sheer Descent, White Lip	\$873.07
1108003	8'	Sheer Descent, White Lip	\$920.27
<b>1" Standard Lip Waterfall - Back Feed</b>			
Light Gray Finish			
1101G	1'	Sheer Descent, Light Gray Lip	\$261.57
1118G	18"	Sheer Descent, Light Gray Lip	\$306.74
1102G	2'	Sheer Descent, Light Gray Lip	\$325.79
1103G	3'	Sheer Descent, Light Gray Lip	\$413.77
1104G	4'	Sheer Descent, Light Gray Lip	\$527.91
1105G	5'	Sheer Descent, Light Gray Lip	\$654.02
1106G	6'	Sheer Descent, Light Gray Lip	\$782.34
1107G	7'	Sheer Descent, Light Gray Lip	\$873.07
1108G	8'	Sheer Descent, Light Gray Lip	\$920.27
<b>1" Standard Lip Waterfall - Back Feed</b>			
Clear Finish			
1101C	1'	Sheer Descent, Clear Lip	\$283.42
1118C	18"	Sheer Descent, Clear Lip	\$328.58
1102C	2'	Sheer Descent, Clear Lip	\$347.63
1103C	3'	Sheer Descent, Clear Lip	\$435.61
1104C	4'	Sheer Descent, Clear Lip	\$549.75
1105C	5'	Sheer Descent, Clear Lip	\$675.86
1106C	6'	Sheer Descent, Clear Lip	\$804.18
1107C	7'	Sheer Descent, Clear Lip	\$894.98
1108C	8'	Sheer Descent, Clear Lip	\$942.11



**Sheer Descent  
Waterfall**

## Sheer Descent® Waterfalls (Continued)

Part No.	Size	Description	List Price
<b>1" Standard Lip Waterfall - Bottom Feed</b>			
Clear Finish			
1001CBF	1'	Sheer Descent, Clear Lip	\$342.87
1018CBF	18"	Sheer Descent, Clear Lip	\$328.58
1002CBF	2'	Sheer Descent, Clear Lip	\$407.06
1003CBF	3'	Sheer Descent, Clear Lip	\$435.61
1004CBF	4'	Sheer Descent, Clear Lip	\$549.75

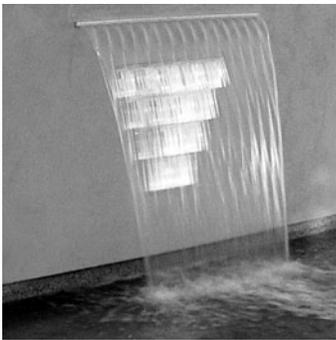

**Sheer Descent  
Extended Lip Waterfall**

## Sheer Descent 6" Extended Lip Waterfalls

6" extended lip waterfalls produce the same effect as the standard 1" lip Sheer Descent Waterfall, but allow for installation of brick or stone on the face of the raised beam. The white, Light Gray and clear lip color waterfalls are easily cut in the field for custom radius curves. When extreme radius curves are required, a Super Radius Waterfall must be special ordered from the factory. See the radius cut guidelines for complete details.

- Creates a clear sheet of water that descends gracefully to the pool surface
- PVC construction
- X-Baffle™ construction

Part No.	Size	Description	List Price
<b>6" Extended Lip Waterfall - Back Feed</b>			
White Finish			
1201003	1'	Sheer Descent, White Lip	\$268.72
1218003	18"	Sheer Descent, White Lip	\$316.27
1202003	2'	Sheer Descent, White Lip	\$342.59
1203003	3'	Sheer Descent, White Lip	\$437.53
1204003	4'	Sheer Descent, White Lip	\$554.05
1205003	5'	Sheer Descent, White Lip	\$687.22
1206003	6'	Sheer Descent, White Lip	\$820.39
1207003	7'	Sheer Descent, White Lip	\$896.49
1208003	8'	Sheer Descent, White Lip	\$972.58
90001		Factory Custom Radius Cut	\$75.00



**Sheer Descent  
Extended Lip Waterfall**

## Sheer Descent 6" Extended Lip Waterfalls (Continued)

Part No.	Size	Description	List Price
<b>6" Extended Lip Waterfall - Back Feed</b>			

Light Gray Finish

1201G	1'	Sheer Descent, Light Gray Lip	\$268.72
1218G	18"	Sheer Descent, Light Gray Lip	\$316.27
1202G	2'	Sheer Descent, Light Gray Lip	\$340.05
1203G	3'	Sheer Descent, Light Gray Lip	\$437.53
1204G	4'	Sheer Descent, Light Gray Lip	\$554.05
1205G	5'	Sheer Descent, Light Gray Lip	\$687.22
1206G	6'	Sheer Descent, Light Gray Lip	\$820.39
1207G	7'	Sheer Descent, Light Gray Lip	\$896.49
1208G	8'	Sheer Descent, Light Gray Lip	\$972.58

<b>6" Extended Lip Waterfall - Back Feed</b>			
--	--	--	--

Clear Finish

1201C	1'	Sheer Descent, Clear Lip	\$290.56
1218C	18"	Sheer Descent, Clear Lip	\$338.11
1202C	2'	Sheer Descent, Clear Lip	\$361.89
1203C	3'	Sheer Descent, Clear Lip	\$459.37
1204C	4'	Sheer Descent, Clear Lip	\$575.90
1205C	5'	Sheer Descent, Clear Lip	\$709.06
1206C	6'	Sheer Descent, Clear Lip	\$842.23
1207C	7'	Sheer Descent, Clear Lip	\$918.33
1208C	8'	Sheer Descent, Clear Lip	\$994.42

<b>6" Extended Lip Waterfall - Bottom Feed</b>			
--	--	--	--

White Finish

1601BF	1'	Sheer Descent, White Lip	\$328.15
1618BF	18"	Sheer Descent, White Lip	\$375.72
1602BF	2'	Sheer Descent, White Lip	\$399.63
1603BF	3'	Sheer Descent, White Lip	\$497.00
1604BF	4'	Sheer Descent, White Lip	\$613.51
90001		Factory Custom Radius Cut	\$75.00

<b>6" Extended Lip Waterfall - Bottom Feed</b>			
--	--	--	--

Clear Finish

1601CBF	1'	Sheer Descent, Clear Lip	\$349.99
1618CBF	18"	Sheer Descent, Clear Lip	\$397.56
1602CBF	2'	Sheer Descent, Clear Lip	\$421.35
1603CBF	3'	Sheer Descent, Clear Lip	\$518.85
1604CBF	4'	Sheer Descent, Clear Lip	\$635.35



**Sheer Descent  
Extended Lip Waterfall**

## Sheer Descent® 12" Super Radius Extended Lip Waterfalls

Part No.	Size	Description	List Price
<b>12" Super Radius Lip Waterfall - Back Feed</b>			
White Finish			
1401J	1'	Sheer Descent, White Lip	\$304.38
1418J	18"	Sheer Descent, White Lip	\$343.41
1402J	2'	Sheer Descent, White Lip	\$411.39
1403J	3'	Sheer Descent, White Lip	\$544.55
1404J	4'	Sheer Descent, White Lip	\$701.48
1405J	5'	Sheer Descent, White Lip	\$870.32
1406J	6'	Sheer Descent, White Lip	\$1,039.16
90001		Factory Custom Radius Cut	\$75.00

<b>12" Super Radius Lip Waterfall - Back Feed</b>			
Light Gray Finish			
1401G	1'	Sheer Descent, Light Gray Lip	\$304.38
1418G	18"	Sheer Descent, Light Gray Lip	\$343.41
1402G	2'	Sheer Descent, Light Gray Lip	\$411.39
1403G	3'	Sheer Descent, Light Gray Lip	\$544.55
1404G	4'	Sheer Descent, Light Gray Lip	\$701.48
1405G	5'	Sheer Descent, Light Gray Lip	\$870.32
1406G	6'	Sheer Descent, Light Gray Lip	\$1,039.16

<b>12" Super Radius Lip Waterfall - Back Feed</b>			
Clear Finish			
1401C	1'	Sheer Descent, Clear Lip	\$326.23
1418C	18"	Sheer Descent, Clear Lip	\$392.80
1402C	2'	Sheer Descent, Clear Lip	\$433.34
1403C	3'	Sheer Descent, Clear Lip	\$566.39
1404C	4'	Sheer Descent, Clear Lip	\$723.33
1405C	5'	Sheer Descent, Clear Lip	\$892.16
1406C	6'	Sheer Descent, Clear Lip	\$1,061.00

<b>12" Super Radius Lip Waterfall - Bottom Feed</b>			
Clear Finish			
1301CBF	1'	Sheer Descent, Clear Lip	\$363.84
1318CBF	18"	Sheer Descent, Clear Lip	\$452.25
1302CBF	2'	Sheer Descent, Clear Lip	\$446.79
1303CBF	3'	Sheer Descent, Clear Lip	\$625.85
1304CBF	4'	Sheer Descent, Clear Lip	\$782.78



**Sheer FiberFall**

## FiberFall®

Lighted waterfalls that produce powerful sheets of water. Single units available.

Part No.	Description	List Price
<b>1" Standard Lip Fiberfall - Back Feed</b>		
FFWS24L	24" Installed with 15' of AD9 Cable	\$978.24
FFWS36L	36" Installed with (2) 15' of AD12 Cable	\$1,662.78
FFWS48L	48" Installed with (2) 15' of AD12 Cable	\$1,887.11

<b>6" Standard Lip Fiberfall - Back Feed</b>		
FFWS24L-6	24" Installed with 15' of AD9 Cable	\$1,151.69
FFWS36L-6	36" Installed with (2) 15' of AD12 Cable	\$1,836.23
FFWS48L-6	48" Installed with (2) 15' of AD12 Cable	\$2,060.56

Zodiac does not recommend fiber longer than 15' from the light driver.

- **Fall cannot be cut in the field.**
- **Radius must be factory cut.**
- **Top of the fall and the acrylic lip, should never be exposed.**

\*(150 Strand Equivalent) Fiber Optic Cable (AD9)

\*\* (225 Strand Equivalent) Fiber Optic Cable (AD12)



**Sheer Curtain Waterfall**

## Sheer Curtain™ Waterfalls

Sheer Curtain Waterfalls produce a clear curtain of water that descends straight down from the unit. It is ideal for cantilever and swim-out installations. Note: If this product is installed on a wall, the wall will be saturated by water.

Part No.	Size	Description	List Price
<b>6" Extended Lip Sheer Curtain Waterfall - Back Feed</b>			
Clear Finish			
1201CSC	1'	Sheer Curtain, Clear Lip	\$373.77
1218CSC	18"	Sheer Curtain, Clear Lip	\$421.35
1202CSC	2'	Sheer Curtain, Clear Lip	\$445.11
1203CSC	3'	Sheer Curtain, Clear Lip	\$547.35
1204CSC	4'	Sheer Curtain, Clear Lip	\$682.90

<b>12" Extended Lip Sheer Curtain Waterfall - Back Feed</b>			
Clear Finish			
1401CSC	1'	Sheer Curtain, Clear Lip	\$457.01
1418CSC	18"	Sheer Curtain, Clear Lip	\$464.13
1402CSC	2'	Sheer Curtain, Clear Lip	\$528.35
1403CSC	3'	Sheer Curtain, Clear Lip	\$661.51
1404CSC	4'	Sheer Curtain, Clear Lip	\$842.23



**Sheer Rain Waterfall**

## Sheer Rain™ Waterfalls

Sheer Rain Waterfalls provide streams of water and project them away from the lip of the waterfall at a 45° angle. The “rain” effect creates a unique waterfall sight and sound. Water requirement for this product is eight (8) U.S. gallons per minute per foot (gpm/ft). The more water provided to the waterfall, the farther out from the wall the “rain” projects.

Part No.	Size	Description	List Price
<b>6" Extended Lip Sheer Rain Waterfalls - Back Feed</b>			
Clear Finish			
1201CSR	1'	Sheer Rain, Clear Nozzle	\$411.39
1218CSR	18"	Sheer Rain, Clear Nozzle	\$480.78
1202CSR	2'	Sheer Rain, Clear Nozzle	\$504.56
1203CSR	3'	Sheer Rain, Clear Nozzle	\$613.94
1204CSR	4'	Sheer Rain, Clear Nozzle	\$742.37
1205CSR	5'	Sheer Rain, Clear Nozzle	\$899.30
1206CSR	6'	Sheer Rain, Clear Nozzle	\$1,032.47
<b>12" Super Radius Lip Sheer Rain Waterfalls - Back Feed</b>			
Clear Finish			
1401CSR	1'	Sheer Rain, Clear Nozzle	\$516.44
1418CSR	18"	Sheer Rain, Clear Nozzle	\$513.32
1402CSR	2'	Sheer Rain, Clear Nozzle	\$575.90
1403CSR	3'	Sheer Rain, Clear Nozzle	\$776.23
1404CSR	4'	Sheer Rain, Clear Nozzle	\$901.68
1405CSR	5'	Sheer Rain, Clear Nozzle	\$1,094.28
1406CSR	6'	Sheer Rain, Clear Nozzle	\$1,263.14





**Sheer Arc Waterfall**

## Sheer Arc™ Waterfalls

Sheer Arc Waterfalls can be positioned just above the waterline—no raised bond beam is required—making it perfect for vinyl liner pools. The fall projects up from the unit at a 45° angle and then naturally arcs and descends to the pool surface. Sheer Arc Waterfalls require double the water flow of a standard Sheer Descent® waterfall. They require 20–30 gallons per minute per linear foot. Sheer Arc Waterfalls are available with clear lips only.

Part No.	Size	Description	List Price
<b>6" Extended Lip Sheer Arc Waterfall - Back Feed</b>			
1201CSA	1'	Sheer Arc, Clear Lip	\$373.77
1218CSA	18"	Sheer Arc, Clear Lip	\$421.35
1202CSA	2'	Sheer Arc, Clear Lip	\$445.11



**Rain Arc Waterfall**

## Rain Arc™ Waterfalls

Rain Arc Waterfalls can be positioned just above the waterline—no raised bond beam is required—making it perfect for vinyl liner pools. The fall projects up from the unit at a 45° angle and then naturally arcs and descends to the pool surface. Rain Arc Waterfalls come with clear nozzles only.

Part No.	Size	Description	List Price
<b>6" Extended Lip Rain Arc Waterfall - Back Feed</b>			
1201CRA	1'	Rain Arc, Clear Nozzle	\$433.23
1218CRA	18"	Rain Arc, Clear Nozzle	\$480.78
1202CRA	2'	Rain Arc, Clear Nozzle	\$504.56
1203CRA	3'	Rain Arc, Clear Nozzle	\$613.94
1204CRA	4'	Rain Arc, Clear Nozzle	\$742.37

## Rain Arc Water Flow Requirements (In U.S. Gallons)

			Waterfall Size				
Height	Projection	Pressure	1'	18"	2'	3'	4'
6"	30"	3 PSI	9 gpm	15 gpm	18 gpm	27 gpm	36 gpm
12"	60"	5 PSI	16 gpm	23 gpm	30 gpm	45 gpm	60 gpm

## SHEER DESCENT® ORDERING INSTRUCTIONS

When ordering Sheer Descent Waterfalls, please indicate style, lip color, feed type and lip size. If ordering a Super Radius cut, please indicate whether the cut should be convex or concave and specify the dimension of the radius.

### Select the following when ordering Sheer Descent Waterfalls:

- Waterfall Style—Sheer Descent, Sheer Curtain™, Sheer Rain™, Sheer Arc™, Rain Arc™
- Lip Color—White, Light Gray and Clear
- Length—1', 18", 2', 3', 4', 5', 6', 7', 8'
- Dimensions—3" Tall, 2½" Deep, 1" Lip
- Feed Type—Back Feed or Bottom Feed
- Lip Size—Standard (1"), Extended (6"), or Super (12")
- Super Radius—Convex or Concave
- 7–10 ft. head loss created. If more water is pushed, more head loss is created.

All Waterfalls take 5–10 business days to ship



**Sheer Descent**



**Sheer Curtain**



**Sheer Rain**



**Sheer Arc**



**Rain Arc**

## Waterfall Height Specification

Waterfalls naturally narrow as they fall. Waterfalls should not be installed more than 3½ feet above the water surface or the sheet will start to break up.

### Water Flow Requirement Chart

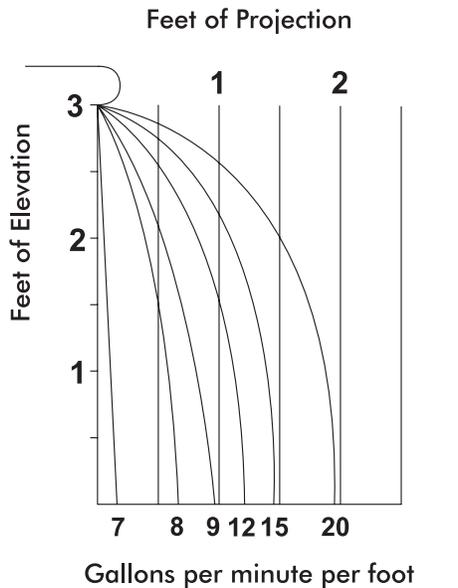

Guideline is for 1 ft. to 4 ft. models

### Hydraulic Guideline Chart

Suction (SUC) and Discharge (DIS) Water Flow Chart for PVC		
Pipe Size	Max SUC Flow*	Max DIS Flow**
1½"	37 GPM	50 GPM
2"	62 GPM	82 GPM
2½"	88 GPM	117 GPM
3"	136 GPM	180 GPM
4"	234 GPM	313 GPM

\*Based on 6' per second velocity. \*\*Based on 8' per second velocity.



Use Zodiac Water Feature Pump

Part No.	Description	GPM
<b>Max (Up) Rated Pumps</b>		
WFTR80	Water Feature Medium Head Pump, 230/115 VAC	80 GPM
WFTR120	Water Feature Medium Head Pump, 230/115 VAC	120 GPM
WFTR160	Water Feature Medium Head Pump, 230/115 VAC	160 GPM

### Pump Sizing and Installation Options

One of the advantages of the Sheer Descent Waterfall is the ability to provide a continuous sheet of water with a minimum of water flow. A standard 4 ft. model, for example, requires only 48 gallons per minute to operate. In order to size your pump properly, refer to the Water Flow Requirement Chart. In most cases, a properly sized standard swimming pool pump will operate the Sheer Descent Waterfall and filter the pool with little loss of total water turnover. As a general rule, the Sheer Descent Waterfall requires approximately 12 gallons per minute per foot with little head loss. For a more dramatic effect, more water gallonage can be applied to project the waterfall further away from the wall.

NOTE: When plumbing multiple falls, add the total length of waterfalls together to determine GPM required. Example: when plumbing two 6' units, you now have 12 feet of waterfall, which requires 144 gallons per minute.

The installation of the Sheer Descent® Waterfall using the main pool filter pump is the most common plumbing system due to the unique low flow aspect of the waterfall system. Simply plumb a 3-way valve on the return line, after the filter, and plumb the waterfall feed line in a minimum of 1½" PVC schedule 40 pipe. Units above 5' in length need a minimum of 2" plumbing.

If multiple waterfalls are being installed, or a Sheer Descent Waterfall 6' or longer is being installed, we recommend installing a separate pump. When plumbing a pump dedicated for use by the Sheer Decent, a separate suction line to the pool must be plumbed. This should be plumbed in a minimum of 2" schedule 40 pipe.

Install at least two (anti-entrapment) suction outlets provided with covers which are listed/certified as complying with ANSI/ASME A112.19.8–2007. Suction outlets (drains) should be installed in accordance with ANSI/APSP–7, the American National Standard for Suction Entrapment Avoidance in Swimming Pools, Wadding Pools, Spas, Hot Tubs, and Catch Basins. The anti-entrapment suction cover is recommended to be positioned 18" above the floor of the pool.

Next, a Sheer Descent filter/strainer (part# 3456), or equivalent, must be installed on the return side of the pump, between the pump and the Sheer Descent Waterfall. A FILTER IS REQUIRED for separate pump installation, as debris (hair and lint) must not be allowed to enter the Sheer Descent unit. For installations requiring up to 60 gallons per minute, use one Sheer Descent filter. For higher water requirements, use two or more filters plumbed in parallel. A separate return line, with a 3-way valve plumbed in such a way that water can be balanced between the Sheer Descent Waterfall and return back to the pool, is also required. See plumbing diagram below.

**ALL Zodiac Water Features (Sheer Descent, Laminar Jets, and Aqua Accents®) MUST HAVE FILTERED WATER.**

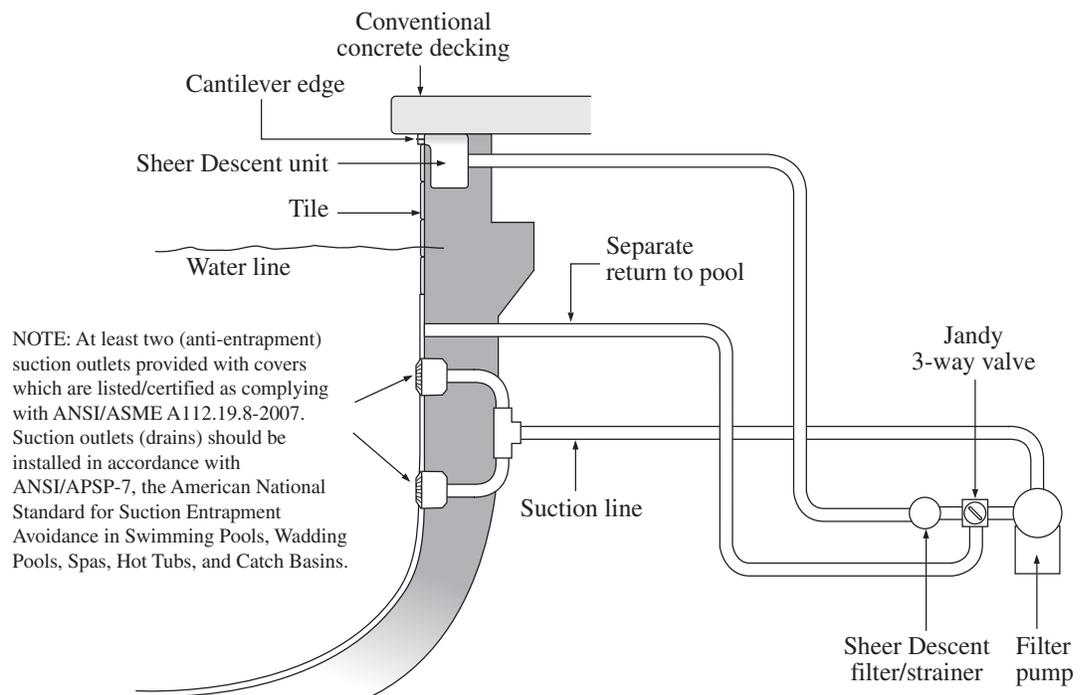

## Sheer Descent® Waterfall Radius Cut Guidelines

Extended lip Sheer Descent Waterfalls can be custom cut in the field to meet specific needs such as curves, irregular shapes, etc. In order to custom fit the waterfall, carefully measure the amount of extended lip to be removed. Remember to leave enough room for tile and thin set, so the deepest edge of the radius cut will not be recessed from the tile line. NOTE: Never remove more than 4½" of the extended lip, leaving a minimum of 1½" of lip. See figure 12. Remove the Lip Protector prior to cutting the waterfall. Remember to replace the Lip Protector after cutting the radius to protect the fall from construction debris. When designing custom curves for the Sheer Descent Extended Lip models, please refer to the Minimum Radius Guidelines Table below to select the correct Sheer Descent model. Super Radius models accommodate very tight radius curves and are available by special order.

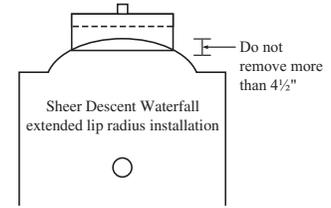

### Table Key

Sheer Descent Model	Abbreviation	Customized Cut
Extended Lip	EL	Field Cut or Factory Cut
Super Radius	SR	Factory Cut Only

### Minimum Radius Guidelines Table

		Sheer Descent Waterfall Length								
		1'	1.5'	2'	3'	4'	5'	6'	7'	8'
Radius										
1'	EL	-	-	-	-	-	-	-	-	-
1.5'	EL	EL	-	-	-	-	-	-	-	-
2"	EL	EL	EL	SR						
2.5'	EL	EL	EL	SR	-	-	-	-	-	-
3'	EL	EL	EL	SR	SR	-	-	-	-	-
3.5'	EL	EL	EL	SR	SR	-	-	-	-	-
4'	EL	EL	EL	EL	SR	-	-	-	-	-
4.5'	EL	EL	EL	EL	SR	SR	-	-	-	-
5'	EL	EL	EL	EL	SR	SR	-	-	-	-
5.5'	EL	EL	EL	EL	SR	SR	-	-	-	-
6'	EL	EL	EL	EL	EL	SR	SR	-	-	-
6.5'	EL	EL	EL	EL	EL	SR	SR	-	-	-
7'	EL	EL	EL	EL	EL	SR	SR	-	-	-
7.5'	EL	EL	EL	EL	EL	SR	SR	-	-	-
8'	EL	EL	EL	EL	EL	SR	SR	-	-	-
8.5'	EL	EL	EL	EL	EL	SR	SR	SR	-	-
9'	EL	EL	EL	EL	EL	SR	SR	SR	-	-
9.5'	EL	EL	EL	EL	EL	EL	SR	SR	-	-
10'	EL	EL	EL	EL	EL	EL	SR	SR	-	-
10.5'	EL	EL	EL	EL	EL	EL	SR	SR	-	-
11'	EL	EL	EL	EL	EL	EL	SR	SR	-	-
12'	EL	EL	EL	EL	EL	EL	SR	SR	-	-
12.5'	EL	EL	EL	EL	EL	EL	EL	SR	SR	-
13'	EL	EL	EL	EL	EL	EL	EL	SR	SR	-

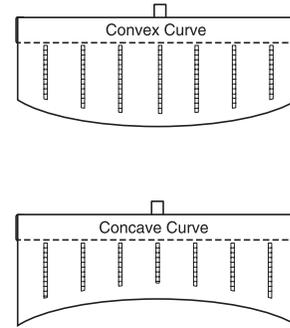



**PowerFalls Custom Falls**

## Zodiac Water Designs Custom Water Features

### PowerFalls Custom Falls

Customized waterfalls that produce powerful sheets of water. These waterfalls can be custom built to various lengths and shapes to match many design applications.

**Recommended Flow Rate: 12 GPM per foot**

**List Price**

Straight PowerFall	\$342.62 per Foot
Curved PowerFall	\$428.27 per Foot
Curved PowerFall w/ Deflector	\$478.27 per Foot
Custom PowerFall Crating	\$30.00 per Foot

(Use PowerFall Custom Fall Quote Form on page 221 for quote request)

Possible PowerFall Deflector options:

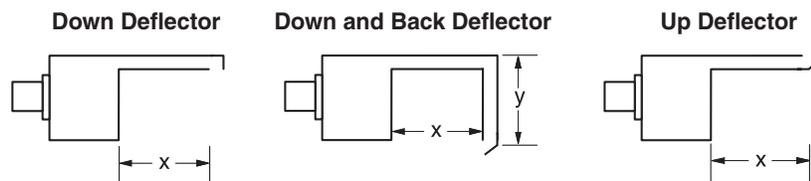

**RainFalls Custom Falls**

### PowerStreams and RainFalls Custom Falls

Customized waterfalls that produce streams of water. These water features can be custom built to various lengths and shapes to provide either streams or rain fall to match design criteria.

**Recommended Flow Rate: 8 GPM per foot**

**List Price**

Straight PowerStream/RainFall	\$363.32 per Foot
Curved PowerStream/RainFall w/ Profile	\$499.68 per Foot
Custom PowerStream/RainFall Crating	\$30.00 per Foot

(Use PowerStream/RainFall Custom Fall Quote Form on page 223 for quote request)

Possible PowerStream/RainFall Profile options:



DATE:		QUOTE:	
-------	--	--------	--



## Custom Fall Quote Form

Fax #: 760-597-1267

Email: [design@zmp-zodiac.com](mailto:design@zmp-zodiac.com)

Completed and signed form required for any fall over 8' or needs customization such as radius, deflector or lip profile.

Builder's Name		ClubP™ #:	
Contact Name:		Email:	
Telephone:		Fax #:	
Distributor:		Branch:	
Contact Name:		Purchase Order #:	
Telephone:		Fax #:	
Email:			

**PowerFall®:** Straight Fall with factory cut radius option.

1. Select Fall length and lip color: (Required flow rate: 12 GPM per foot)

Length of Waterfall:		Feet		Inches
Color:	<input type="checkbox"/> White	<input type="checkbox"/> Clear	<input type="checkbox"/> Light Gray	

2. Select lip length:

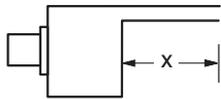

3. Select Inlet Fitting Location:

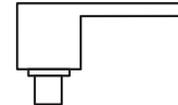
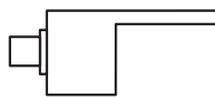

Lip Length X=	<input type="checkbox"/> 1" <input type="checkbox"/> 6" <input type="checkbox"/> 12"	<input type="checkbox"/> 1½ x 2" Rear Feed	<input type="checkbox"/> 1½ x 2" Bottom Feed
---------------	--	--	--

4. (OPTIONAL) Select deflector: (choose only one)

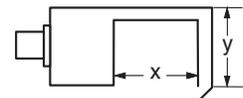
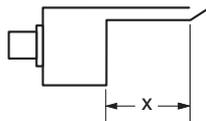
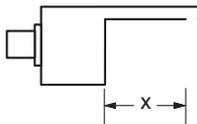

<input type="checkbox"/> Down Deflector	<input type="checkbox"/> Up Deflector	<input type="checkbox"/> Down & Back Deflector
X= <input type="checkbox"/> 1" <input type="checkbox"/> 6" <input type="checkbox"/> 12"	X= <input type="checkbox"/> 1" <input type="checkbox"/> 6" <input type="checkbox"/> 12"	X= <input type="checkbox"/> Y= <input type="checkbox"/> In.

Minimum "X" dimension must be at least 1-1/2"

Minimum "Y" dimension must be at least 2-7/8"

For Radius option, proceed to step 5.

(OPTIONAL)

5 . Radius Cuts:

Check ONE of these Radius styles:

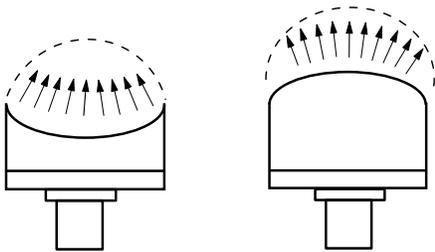

Concave Radius       Convex Radius

- Upon completion of proper sizes, write radius here:

Ft.  In.

Was radius template sent to Zodiac?

Yes       No

Any customized waterfall over 8 feet in length is a multi-unit. Determined at the factory, each unit will have an X-Baffle and water inlets to ensure proper water flow.

Example (top view with back water inlets):

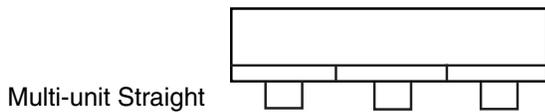

Multi-unit Straight

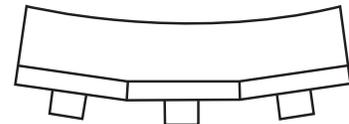

Multi-unit Radius

- Only front of waterfall is Radius cut; back of waterfall is not cut.
- For pricing or assistance with design on waterfalls over 8', call Zodiac Pool Systems, Inc. at 1-800-822-7933.

Sheer Descent Length

	12"	18"	24"	36"	48"	60"	72"	84"	96"
1'	6" Lip	6" Lip	Custom	Custom	N/A	N/A	N/A	N/A	N/A
1.5'	6" Lip	6" Lip	6" Lip	Custom	Custom	N/A	N/A	N/A	N/A
2'	6" Lip	6" Lip	6" Lip	12" Lip	Custom	Custom	N/A	N/A	N/A
2.5'	6" Lip	6" Lip	6" Lip	12" Lip	Custom	Custom	Custom	N/A	N/A
3'	6" Lip	6" Lip	6" Lip	6" Lip	12" Lip	Custom	Custom	Custom	N/A
3.5'	6" Lip	6" Lip	6" Lip	6" Lip	12" Lip	Custom	Custom	Custom	Custom
4'	6" Lip	6" Lip	6" Lip	6" Lip	12" Lip	12" Lip	Custom	Custom	Custom
4.5'	6" Lip	6" Lip	6" Lip	6" Lip	12" Lip	12" Lip	Custom	Custom	Custom
5'	6" Lip	6" Lip	6" Lip	6" Lip	12" Lip	12" Lip	Custom	Custom	Custom
5.5'	6" Lip	6" Lip	6" Lip	6" Lip	6" Lip	12" Lip	12" Lip	Custom	Custom
6'	6" Lip	6" Lip	6" Lip	6" Lip	6" Lip	12" Lip	12" Lip	Custom	Custom
6.5'	6" Lip	6" Lip	6" Lip	6" Lip	6" Lip	12" Lip	12" Lip	Custom	Custom
7'	6" Lip	6" Lip	6" Lip	6" Lip	6" Lip	12" Lip	12" Lip	Custom	Custom
7.5'	6" Lip	6" Lip	6" Lip	6" Lip	6" Lip	12" Lip	12" Lip	Custom	Custom
8'	6" Lip	6" Lip	6" Lip	6" Lip	6" Lip	6" Lip	12" Lip	12" Lip	Custom
8.5'	6" Lip	6" Lip	6" Lip	6" Lip	6" Lip	6" Lip	12" Lip	12" Lip	Custom
9'	6" Lip	6" Lip	6" Lip	6" Lip	6" Lip	6" Lip	12" Lip	12" Lip	Custom
9.5'	6" Lip	6" Lip	6" Lip	6" Lip	6" Lip	6" Lip	12" Lip	12" Lip	12" Lip
10'	6" Lip	6" Lip	6" Lip	6" Lip	6" Lip	6" Lip	12" Lip	12" Lip	12" Lip
10.5'	6" Lip	6" Lip	6" Lip	6" Lip	6" Lip	6" Lip	12" Lip	12" Lip	12" Lip
11'	6" Lip	6" Lip	6" Lip	6" Lip	6" Lip	6" Lip	6" Lip	12" Lip	12" Lip
11.5'	6" Lip	6" Lip	6" Lip	6" Lip	6" Lip	6" Lip	6" Lip	12" Lip	12" Lip
12'	6" Lip	6" Lip	6" Lip	6" Lip	6" Lip	6" Lip	6" Lip	12" Lip	12" Lip
12.5'	6" Lip	6" Lip	6" Lip	6" Lip	6" Lip	6" Lip	6" Lip	12" Lip	12" Lip
13'	6" Lip	6" Lip	6" Lip	6" Lip	6" Lip	6" Lip	6" Lip	12" Lip	12" Lip

Radius Size

BUILDER TIPS

- Due to potential alignment issues, multi-unit waterfalls should be plumbed using installation guide.
- Valve each separate waterfall feed.
- Install an in-line filter for dedicated waterfall pump lines with all custom falls.
- Lip and Body must be properly supported.
- PowerFall installation must not exceed 3-1/2 feet above pool surface to ensure laminar sheet of water.

POOL BUILDER MUST SIGN:

Please check your specifications and the Zodiac confirmation carefully. This is a custom product that is created by the information you provide. Zodiac is not responsible for errors in measurements or alterations that occur in the pool design.

Approved Signature \_\_\_\_\_ Date \_\_\_\_\_



DATE:		QUOTE:	
-------	--	--------	--



## Custom Fall Quote Form

Fax #: 760-597-1267

Email: [design@zmp-zodiac.com](mailto:design@zmp-zodiac.com)

Completed and signed form required for any fall over 8' or with customization such as radius, deflector or lip profile.

Builder's Name		ClubP™ #:	
Contact Name:		Email:	
Telephone:		Fax #:	
Distributor:		Branch:	
Contact Name:		Purchase Order #:	
Telephone:		Fax #:	
Email:			

### PowerStreams® & RainFall®: (One Fall per quote form.)

1. Select waterfall length and color: (Required flow rate: 8 GPM per foot)

Length of Waterfall:		Feet		Inches
Color:	<input type="checkbox"/> White	<input type="checkbox"/> Clear	<input type="checkbox"/> Gray	

2. Select lip length:

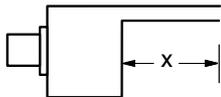

Lip Length X=

1"    6"    12"

3. Select water feed and fitting size: (choose only one)

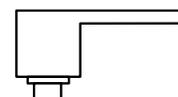
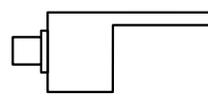

1½ x 2" Rear Feed

1½ x 2" Bottom Feed

4. PowerStreams and RainFalls will come with a 2-row Nozzle Insert: Requires 8 gallons per foot.



5. (OPTIONAL) Select Lip Profile (choose only one)

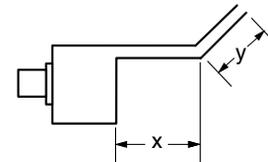
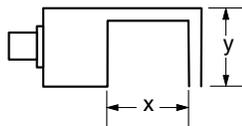

Lip Profile "A"

Lip Profile "C"

X=	<input type="checkbox"/> 1"	<input type="checkbox"/> 6"	<input type="checkbox"/> 12"	Y=	In.	X=	<input type="checkbox"/> 1"	<input type="checkbox"/> 6"	<input type="checkbox"/> 12"	Y=	In.
----	-----------------------------	-----------------------------	------------------------------	----	-----	----	-----------------------------	-----------------------------	------------------------------	----	-----

Minimum "Y" dimension must be at least 1½"

For Radius option, proceed to step 6.

(OPTIONAL)

6. Radius Cuts:

Check ONE of these Radius styles:

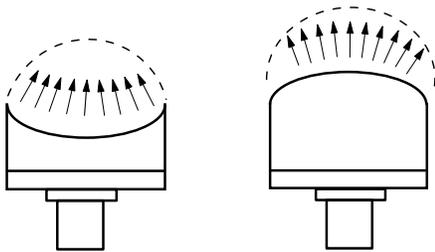

Concave Radius       Convex Radius

- Upon completion of proper sizes, write radius here:

	Ft.		In.
--	-----	--	-----

Was radius template sent to Zodiac?

Yes       No

Any customized waterfall over 8 feet in length is a multi-unit. Determined at the factory, each unit will have an X-Baffle and water inlets to ensure proper water flow.

Example (top view with back water inlets):

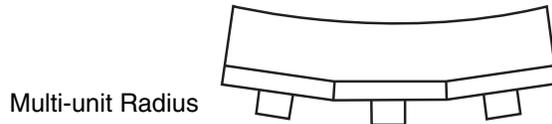
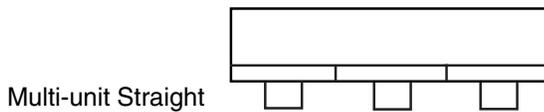

- Only front of waterfall is Radius cut; back of waterfall is not cut.
- For pricing or assistance with design on waterfalls over 8', call Zodiac Pool Systems, Inc. at 1-800-822-7933.

**Sheer Descent Length**

	12"	18"	24"	36"	48"	60"	72"	84"	96"
1'	6" Lip	6" Lip	Custom	Custom	N/A	N/A	N/A	N/A	N/A
1.5'	6" Lip	6" Lip	6" Lip	Custom	Custom	N/A	N/A	N/A	N/A
2'	6" Lip	6" Lip	6" Lip	12" Lip	Custom	Custom	N/A	N/A	N/A
2.5'	6" Lip	6" Lip	6" Lip	12" Lip	Custom	Custom	Custom	N/A	N/A
3'	6" Lip	6" Lip	6" Lip	6" Lip	12" Lip	Custom	Custom	Custom	N/A
3.5'	6" Lip	6" Lip	6" Lip	6" Lip	12" Lip	Custom	Custom	Custom	Custom
4'	6" Lip	6" Lip	6" Lip	6" Lip	12" Lip	12" Lip	Custom	Custom	Custom
4.5'	6" Lip	6" Lip	6" Lip	6" Lip	12" Lip	12" Lip	Custom	Custom	Custom
5'	6" Lip	6" Lip	6" Lip	6" Lip	12" Lip	12" Lip	Custom	Custom	Custom
5.5'	6" Lip	6" Lip	6" Lip	6" Lip	6" Lip	12" Lip	12" Lip	Custom	Custom
6'	6" Lip	6" Lip	6" Lip	6" Lip	6" Lip	12" Lip	12" Lip	Custom	Custom
6.5'	6" Lip	6" Lip	6" Lip	6" Lip	6" Lip	12" Lip	12" Lip	Custom	Custom
7'	6" Lip	6" Lip	6" Lip	6" Lip	6" Lip	12" Lip	12" Lip	Custom	Custom
7.5'	6" Lip	6" Lip	6" Lip	6" Lip	6" Lip	12" Lip	12" Lip	Custom	Custom
8'	6" Lip	6" Lip	6" Lip	6" Lip	6" Lip	6" Lip	12" Lip	12" Lip	Custom
8.5'	6" Lip	6" Lip	6" Lip	6" Lip	6" Lip	6" Lip	12" Lip	12" Lip	Custom
9'	6" Lip	6" Lip	6" Lip	6" Lip	6" Lip	6" Lip	12" Lip	12" Lip	Custom
9.5'	6" Lip	6" Lip	6" Lip	6" Lip	6" Lip	6" Lip	12" Lip	12" Lip	12" Lip
10'	6" Lip	6" Lip	6" Lip	6" Lip	6" Lip	6" Lip	12" Lip	12" Lip	12" Lip
10.5'	6" Lip	6" Lip	6" Lip	6" Lip	6" Lip	6" Lip	12" Lip	12" Lip	12" Lip
11'	6" Lip	6" Lip	6" Lip	6" Lip	6" Lip	6" Lip	6" Lip	12" Lip	12" Lip
11.5'	6" Lip	6" Lip	6" Lip	6" Lip	6" Lip	6" Lip	6" Lip	12" Lip	12" Lip
12'	6" Lip	6" Lip	6" Lip	6" Lip	6" Lip	6" Lip	6" Lip	12" Lip	12" Lip
12.5'	6" Lip	6" Lip	6" Lip	6" Lip	6" Lip	6" Lip	6" Lip	12" Lip	12" Lip
13'	6" Lip	6" Lip	6" Lip	6" Lip	6" Lip	6" Lip	6" Lip	12" Lip	12" Lip

Radius Size

**BUILDER TIPS**

- Due to potential alignment issues, multi-unit waterfalls should be plumbed using installation guide.
- Valve each separate waterfall feed.
- Install an in-line filter for dedicated waterfall pump lines with all custom falls.
- Lip and Body must be properly supported.
- PowerFall installation must not exceed 3-1/2 feet above pool surface to ensure laminar sheet of water.

**POOL BUILDER MUST SIGN:**

Please check your specifications and the Zodiac confirmation carefully. This is a custom product that is created by the information you provide. Zodiac is not responsible for errors in measurements or alterations that occur in the pool design.

Approved Signature \_\_\_\_\_ Date \_\_\_\_\_



## Aqua Accents®

Aqua Accents are another water feature innovation from Zodiac. All pieces are made from a lightweight blended polymer and resist chipping, cracking and fading. Aqua Accents are available in a natural stone finish and three metal finishes. To create the metal finishes, genuine metal is molecularly bonded to the piece so it appears to be solid bronze, copper or silver nickel. Because actual metal is used, these finishes will acquire a beautiful patina over time.



**Roman Lion**



**Victorian Lion**



**Renaissance Lion**



**Regal Lion**



**Circle of Leaves**



**4 Point Leaves**

Part No.	Description	Shipping Weight (lbs.)	List Price
<b>Lion Heads</b>			
20802	Roman Lion, 8½" x 10½", Natural Stone	3.75	\$145.12
20805	Roman Lion, 8½" x 10½", Copper*	3.75	\$263.74
20806	Roman Lion, 8½" x 10½", Silver Nickel*	3.75	\$263.74
20807	Roman Lion, 8½" x 10½", Bronze	3.75	\$263.74
20902	Victorian Lion, 6½" x 7", Natural Stone	1.95	\$114.42
20905	Victorian Lion, 6½" x 7", Copper*	1.95	\$220.45
20906	Victorian Lion, 6½" x 7", Silver Nickel*	1.95	\$220.45
20907	Victorian Lion, 6½" x 7", Bronze	1.95	\$220.45
21002	Renaissance Lion, 8" x 8", Nat. Stone	1.75	\$114.42
21005	Renaissance Lion, 8" x 8", Copper*	1.75	\$220.45
21006	Renaissance Lion, 8" x 8", Silver Nickel*	1.75	\$220.45
21007	Renaissance Lion, 8" x 8", Bronze	1.75	\$220.45
21302	Regal Lion, 9" x 12½", Natural Stone	4.75	\$198.13
21305	Regal Lion, 9" x 12½", Copper*	4.75	\$336.27
21306	Regal Lion, 9" x 12½", Silver Nickel*	4.75	\$336.27
21307	Regal Lion, 9" x 12½", Bronze	4.75	\$336.27
<b>Rosettes</b>			
21502	Circle of Leaves, 7" x 7", Natural Stone	1.5	\$94.88
21505	Circle of Leaves, 7" x 7", Copper*	1.5	\$189.77
21506	Circle of Leaves, 7" x 7", Silver Nickel*	1.5	\$189.77
21507	Circle of Leaves, 7" x 7", Bronze	1.5	\$189.77
21702	4 Point Leaves, 6" x 6", Natural Stone	1.5	\$94.88
21705	4 Point Leaves, 6" x 6", Copper*	1.5	\$189.77
21706	4 Point Leaves, 6" x 6", Silver Nickel*	1.5	\$189.77
21707	4 Point Leaves, 6" x 6", Bronze	1.5	\$189.77

(Photos not actual size)

\* Special order item, please allow two (2) weeks for delivery.

## Aqua Accents® (Continued)



Part No.	Description	Shipping Weight (lbs.)	List Price
<b>Rosettes Continued</b>			
21802	Scalloped Edge, 8" x 8", Natural Stone	1.75	\$108.84
21805	Scalloped Edge, 8" x 8", Copper*	1.75	\$203.72
21806	Scalloped Edge, 8" x 8", Silver Nickel*	1.75	\$203.72
21807	Scalloped Edge, 8" x 8", Bronze	1.75	\$203.72
21902	Sunflower, 8" x 6¼", Natural Stone	2.0	\$94.88
21905	Sunflower, 8" x 6¼", Copper*	2.0	\$189.77
21906	Sunflower, 8" x 6¼", Silver Nickel*	2.0	\$189.77
21907	Sunflower, 8" x 6¼", Bronze	2.0	\$189.77
22002	Sunflower, 14" x 11½", Natural Stone	3.5	\$185.60
22005	Sunflower, 14" x 11½", Copper*	3.5	\$293.01
22006	Sunflower, 14" x 11½", Silver Nickel*	3.5	\$293.01
22007	Sunflower, 14" x 11½", Bronze	3.5	\$293.01
22102	Star, 4½" x 4½", Natural Stone	1.5	\$94.88
22105	Star, 4½" x 4½", Copper*	1.5	\$189.77
22106	Star, 4½" x 4½", Silver Nickel*	1.5	\$189.77
22107	Star, 4½" x 4½", Bronze	1.5	\$189.77
22202	Star, 6¾" x 6¾", Natural Stone	1.75	\$108.84
22205	Star, 6¾" x 6¾", Copper*	1.75	\$203.72
22206	Star, 6¾" x 6¾", Silver Nickel*	1.75	\$203.72
22207	Star, 6¾" x 6¾", Bronze	1.75	\$203.72
22302	Oak Leaf, 4½" x 4½", Natural Stone	1.5	\$94.88
22305	Oak Leaf, 4½" x 4½", Copper*	1.5	\$189.77
22306	Oak Leaf, 4½" x 4½", Silver Nickel*	1.5	\$189.77
22307	Oak Leaf, 4½" x 4½", Bronze	1.5	\$189.77
22602	Round, 8½" Dia., Natural Stone	2.5	\$108.84
22605	Round, 8½" Dia., Copper*	2.5	\$203.72
22606	Round, 8½" Dia., Silver Nickel*	2.5	\$203.72
22607	Round, 8½" Dia., Bronze	2.5	\$203.72
22802	Square Dahlia, 10½" x 10½", Natural St.	3.5	\$126.99
22805	Square Dahlia, 10½" x 10½", Copper*	3.5	\$214.86
22806	Square Dahlia, 10½" x 10½", Silver Ni.*	3.5	\$214.86
22807	Square Dahlia, 10½" x 10½", Bronze	3.5	\$214.86

(Photos not actual size)

\* Special order item, please allow two (2) weeks for delivery.

## Aqua Accents® (Continued)



**Fleur De Coeur**



**Fleur De Lis**



**Versailles**



**Bastion**



**Gothic**



**Tuscany**



**Corinthian**



**Polynesia**

Part No.	Description	Shipping Weight (lbs.)	List Price
<b>Sconces Continued</b>			
22902	Fleur de Coeur, 9" x 7", Natural Stone	3.0	\$213.44
22905	Fleur de Coeur, 9" x 7", Copper*	3.0	\$329.75
22906	Fleur de Coeur, 9" x 7", Silver Nickel*	3.0	\$329.75
22907	Fleur de Coeur, 9" x 7", Bronze	3.0	\$329.75
23002	Fleur de Lis, 21" x 12", Natural Stone	9.5	\$316.74
23005	Fleur de Lis, 21" x 12", Copper*	9.5	\$530.22
23006	Fleur de Lis, 21" x 12", Silver Nickel*	9.5	\$530.22
23007	Fleur de Lis, 21" x 12", Bronze	9.5	\$530.22
23102	Versailles, 16" x 11½", Natural Stone	6.5	\$316.74
23105	Versailles, 16" x 11½", Copper*	6.5	\$530.22
23106	Versailles, 16" x 11½", Silver Nickel*	6.5	\$530.22
23107	Versailles, 16" x 11½", Bronze	6.5	\$530.22
23202	Bastion, 12½" x 6", Natural Stone	3.5	\$168.83
23205	Bastion, 12½" x 6", Copper*	3.5	\$291.63
23206	Bastion, 12½" x 6", Silver Nickel*	3.5	\$291.63
23207	Bastion, 12½" x 6", Bronze	3.5	\$291.63
23302	Gothic, 12½" x 6", Natural Stone	3.5	\$168.83
23305	Gothic, 12½" x 6", Copper*	3.5	\$291.63
23306	Gothic, 12½" x 6", Silver Nickel*	3.5	\$291.63
23307	Gothic, 12½" x 6", Bronze	3.5	\$291.63
23602	Tuscany, 13¼" x 6¾", Natural Stone	6.5	\$253.79
23605	Tuscany, 13¼" x 6¾", Copper	6.5	\$427.09
23606	Tuscany, 13¼" x 6¾", Silver Nickel	6.5	\$427.09
23607	Tuscany, 13¼" x 6¾", Bronze	6.5	\$427.09
23702	Corinthian, 8" x 8½", Natural Stone	2.5	\$189.68
23705	Corinthian, 8" x 8½", Copper	2.5	\$313.14
23706	Corinthian, 8" x 8½", Silver Nickel	2.5	\$313.14
23707	Corinthian, 8" x 8½", Bronze	2.5	\$313.14
23802	Polynesia, 7¼" x 7", Natural Stone	3.0	\$213.44
23805	Polynesia, 7¼" x 7", Copper	3.0	\$329.75
23806	Polynesia, 7¼" x 7", Silver Nickel	3.0	\$329.75
23807	Polynesia, 7¼" x 7", Bronze	3.0	\$329.75

(Photos not actual size)

\* Special order item, please allow two (2) weeks for delivery.



**Sonrisa**



**Conch Shell**



**Shell**



**St. Lucie**



**St. Augustine**

## Aqua Accents® (Continued)

Part No.	Description	Shipping Weight (lbs.)	List Price
<b>Sconces Continued</b>			
23902	Sonrisa, 14½" x 7", Natural Stone	6.5	\$253.79
23905	Sonrisa, 14½" x 7", Copper	6.5	\$427.09
23906	Sonrisa, 14½" x 7", Silver Nickel	6.5	\$427.09
23907	Sonrisa, 14½" x 7", Bronze	6.5	\$427.09
<b>Shells</b>			
24002	Conch, 5½" x 6½", Natural Stone	1.5	\$94.88
24005	Conch, 5½" x 6½", Copper*	1.5	\$189.77
24006	Conch, 5½" x 6½", Silver Nickel*	1.5	\$189.77
24007	Conch, 5½" x 6½", Bronze	1.5	\$189.77
<b>Hand Holds</b>			
24302	Shell, 7" x 5½", Natural Stone	1.75	\$57.23
24305	Shell, 7" x 5½", Copper*	1.75	\$115.83
24306	Shell, 7" x 5½", Silver Nickel*	1.75	\$115.83
24307	Shell, 7" x 5½", Bronze	1.75	\$115.83
<b>Hand Holds</b>			
24402	St. Lucie, 7" x 5½", Natural Stone	1.5	\$80.48
24405	St. Lucie, 7" x 5½", Copper	1.5	\$142.21
24406	St. Lucie, 7" x 5½", Silver Nickel	1.5	\$142.21
24407	St. Lucie, 7" x 5½", Bronze	1.5	\$142.21
24502	St. Augustine, 6" x 7", Natural Stone	1.5	\$80.48
24505	St. Augustine, 6" x 7", Copper	1.5	\$142.21
24506	St. Augustine, 6" x 7", Silver Nickel	1.5	\$142.21
24507	St. Augustine, 6" x 7", Bronze	1.5	\$142.21

(Photos not actual size)

\* Special order item, please allow two (2) weeks for delivery.

## Laminar Jets with LED

Zodiac Laminar Jets with LED create spectacular backyard water entertainment with dazzling nighttime lighting effects. They produce clear or lighted arcs of water as they silently enter your pool or spa.

- Laminar Jets with LED come standard with a built-in 12V LED light module
- Laminar Jets interface easily with Aqualink® RS and PDA controllers to synchronize with Zodiac Watercolors™ LED Pool and Spa Lights
- Laminar Jets are also available with the unique Pour-A-Lid™ option, enabling easy coordination with your deck finish
- Laminar Jets are easily adjusted at the deck to create arcs of water up to 7 ft. high and can project 8 ft. into the pool. Flow can be adjusted with an innovative internal flow adjustment valve conveniently located inside the canister for easy adjustment and tuning



Pebble  
Included



Pewter Option

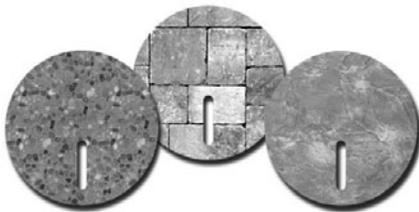

\* Pour-A-Lid  
Option

\*Pour-A-Lid is a trademark  
of Stetson Development, Inc.

Part No.	Description	List Price
JLLED	Laminar Jet with Pebble Lid, Deck Ring, Canister & LED Light Module with 100' of Electrical Cable	\$990.30
JLFBR	Laminar Jet with Lid, Deck Ring, Canister & Fiber Optic Ready Module	\$615.35
JLPBBL	Lid and Collar, Pebble	\$76.72
JLPWTR	Lid and Collar, Pewter	\$76.72
JLPAL	Pour-A-Lid Collar, Clear	\$97.32



## Deck Jets™

The Zodiac Deck Jets create shimmering arcs of water from the deck into the pool or spa. Polished bronze composite coverplates provide a rich finish to the installed jets. The Deck Jets can be installed in almost any combination, and since they can be adjusted 360°, the dazzling effects they create can be changed again and again to meet your customer's mood.

The Deck Jets are packed in a set of four and include a pressure plug along with the polished bronze composite deck coverplates. They are 2½ inches in diameter.

- Polished bronze composite coverplates provide an elegant finish
- Fully adjustable (up to 360°) swivel nozzles
- Packaged in a set of four. Includes pressure testing plug



Deck Jets

Part No.	Description	Price List
JDJ2004	Zodiac Deck Jets, (4 pack)	\$431.97



### Typical Deck Jet Installation

Deck Jet Water Volume & Pressure Chart			
Gallons (US GPM)	3.0	4.0	5.0
Feet of Head	3.9	7.9	11.0
Height of Jet	3.0	6.6	10.0





**Minijet**

## Minijet®

MiniJets can be mounted in the deck or pool wall. Single units available.

Part No.	Description	Price List
FCMJ1000	FlowControl, Adjustable Nozzle Minijet, Complete (pack of 4, includes 4 brass and 4 white cover plates)	\$558.76
FCMJ1050	FlowControl, Adjustable Nozzle with Adjustment Tool	\$77.90
FCMJ6400	FlowControl, Adjustment Tool Replacement	\$25.96
FFMJ	Standard Minijet Niche with Comet Nozzle for Gunite Pools, includes white cover plate	\$92.93
FFMJ-FN1	Minijet Fan Nozzle (3/8")	\$100.89
FFMJ-FN2	Minijet Fan Nozzle (1/2")	\$100.89
FFMJ-VL	Minijet Niche with Comet Nozzle for Vinyl Pools	\$132.74
OA89009	Nozzle, Comet 3-3T (3/8")	\$50.34
OA89012	Nozzle, Comet 3-6T (3/8")	\$31.80

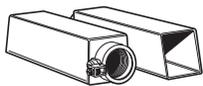

Plumbed Spillway  
with 1" threaded fitting  
4-8 GPM



Non-plumbed Spillway  
with Flange

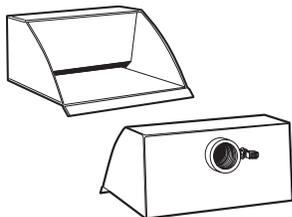

Scuppers  
with 1" threaded fitting  
16 GPM

## PC Spillways and Scuppers

Plumbed or simple mini spillways for fountains, spas and pools. Decorative scuppers for pool and deck overhangs.

Part No.	Description	Price List
<b>PC Spillway</b>		
PC501	Spillway, 8" Stainless, Plumb Fitting, 3 pack	\$614.56
PC601	Spillway, 12" Stainless, Non-Plumb, 12 pack	\$933.75
<b>Scupper</b>		
PS101	Scupper, Stainless, 8" x 8" x 4", Back Feed	\$524.04
PS102	Scupper, Stainless, 8" x 8" x 4", Bottom Feed	\$524.04
PS201	Scupper, Copper, 8" x 8" x 4", Back Feed	\$590.74
PS202	Scupper, Copper, 8" x 8" x 4", Bottom Feed	\$590.74

## Minijet® Parts

Part No.	Description	Price List
MJ10	MiniJet Conversion w/ White Cover Plate, Screws, Comet Nozzle (3-6T)	\$42.15
FJ10	FanJet Conversion w/ White Cover Plate, Screws, FanJet Nozzle (3/8")	\$45.16
MJ6300	MiniJet Cover Plate, Screws, White	\$16.42
MJ6320	MiniJet Cover Plate, Screws, Dove Gray	\$16.42
MJ6330	MiniJet Cover Plate, Screws, Beige	\$16.42
MJ6350	MiniJet Cover Plate, Screws, Black	\$16.42
MJ6370	MiniJet Cover Plate, Screws, Brass	\$24.08
MJ6170	MiniJet Cover Plate, Blue, Light Gray, Rust Marble Finish	\$21.08
MJ6180	MiniJet Cover Plate, Green, Rust, Blue Marble	\$21.08
MJ6190	MiniJet Cover Plate, Beige, Brown Marble	\$21.08
V100	Vinyl Pool MiniJet Cap, Screws, White	\$21.08
V120	Vinyl Pool MiniJet Cap, Screws, Dove Gray	\$21.08
V130	Vinyl Pool MiniJet Cap, Screws, Beige	\$21.08
V150	Vinyl Pool MiniJet Cap, Screws, Black	\$21.08

## Deck Jets Parts

Part No.	Description	Price List
R0561200	Replacement Coverplate, (4 pack)	\$51.41
R0560400	Nozzle Replacements, (4 pack)	\$99.36

## Water Feature Accessories

Part No.	Description	Price List
1902J	Rocktrap	\$33.99
3456	Sheer Descent® Filter/Strainer	\$92.06
5000J	Sheer Descent Repair Kit	\$80.08

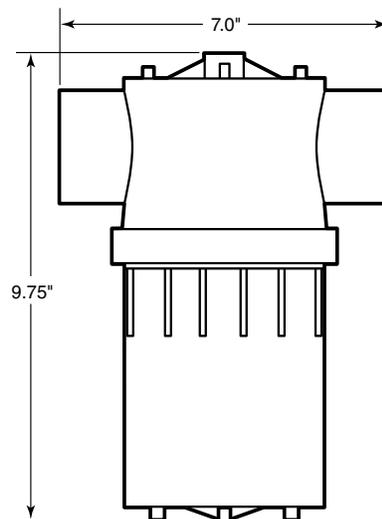

Sheer Descent Filter/Strainer  
Part No. 3456

## Laminar Jet with LED Parts Diagram

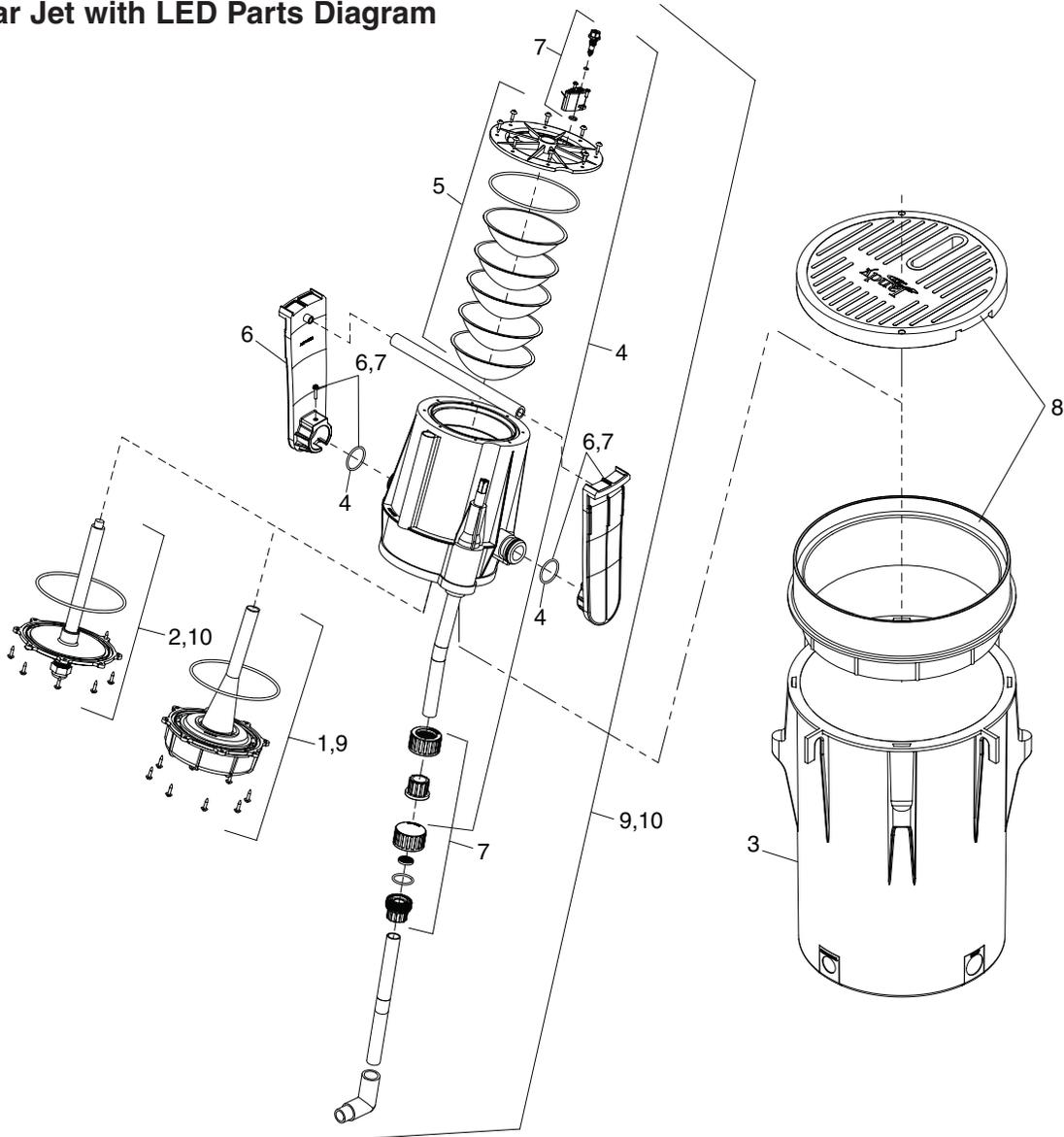

Key No.	Part No.	Description	Model	List Price
1	R0488800	LED Light Engine Assy, Laminar Jet	All	\$717.35
2	R0488900	Fiber Optic Assy, Laminar Jet	All	\$189.29
3	R0489100	Deck Canister, Laminar Jet	All	\$173.05
4	R0489200	Jet Assy, Laminar Jet (No Light Module)	All	\$169.48
5	R0489300	Cover and Screens (5), Laminar Jet Assy	All	\$56.27
6	R0489500	Mounting Brackets and Hardware, Laminar Jet	All	\$29.76
7	R0490000	Rebuild Kit, All Hardware, Scratcher, Finger Screen	All	\$50.55
8	JLPBBL	Lid and Collar, Pebble, Laminar Jet,	All	\$76.72
8a	JLPWTR	Lid and Collar, Pewter, Laminar Jet	All	\$76.72
8b	JLPAL	Pour-A-Lid™ and Collar,Clear, Laminar Jet (Not Shown)	All	\$97.32
9	R0499900	Laminar Jet w/ LED light Retrofit Kit	All	\$901.06
10	R0500300	Laminar Jet w/ Fiber Optic Retrofit Kit	All	\$399.50